

Article number: 12308100050110  
Description: KLEE-coil 308 100 050.110  
M5 Hardened/zinc-plated Blue

## Measures

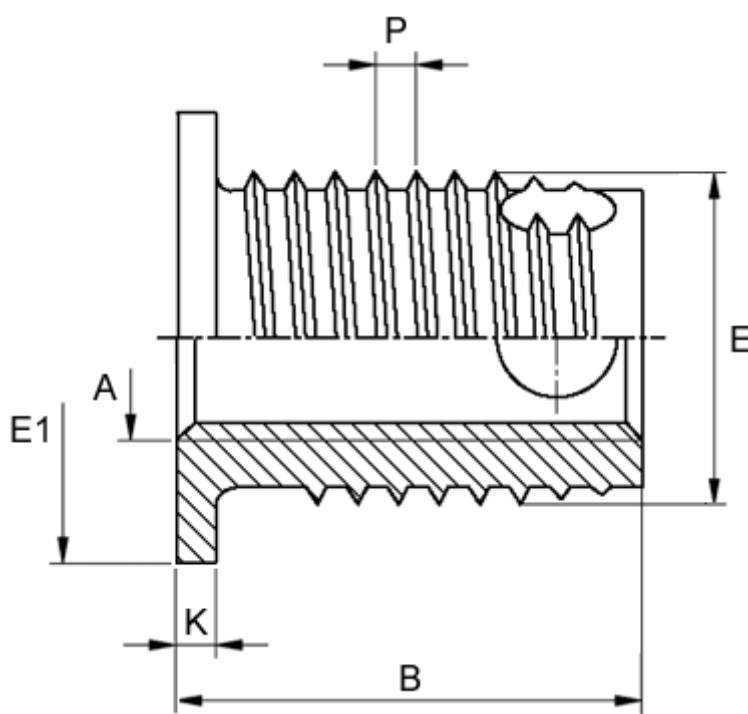

Female thread A	= M5
Flange diameter E1	= 11
Flange height	= 1.0
Length B	= 11.0
Male thread E	= 8
Min hole depth blind hole	= 13
Thread pitch P	= 1.00
Type	= 308 100 050 ...